

emp.4-A

emp.4-B

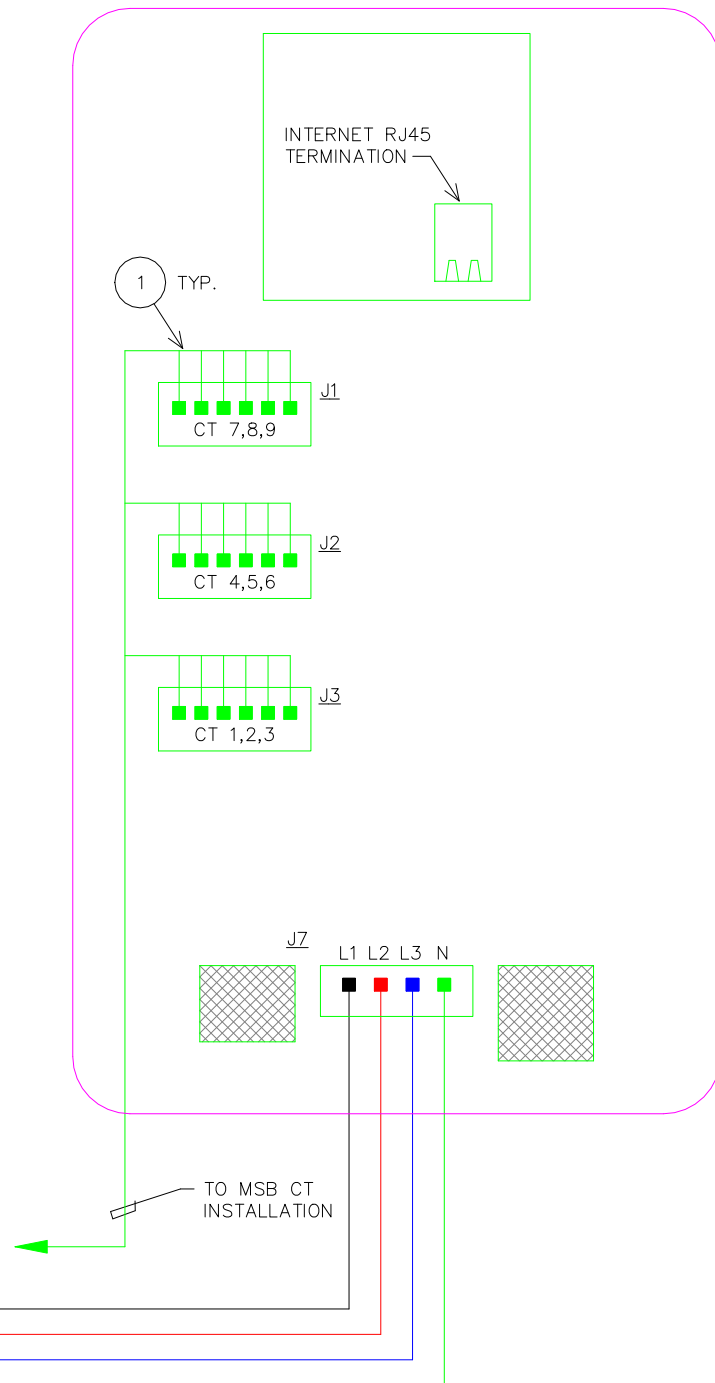

5235 S. 39th Street
PHOENIX, AZ 85040

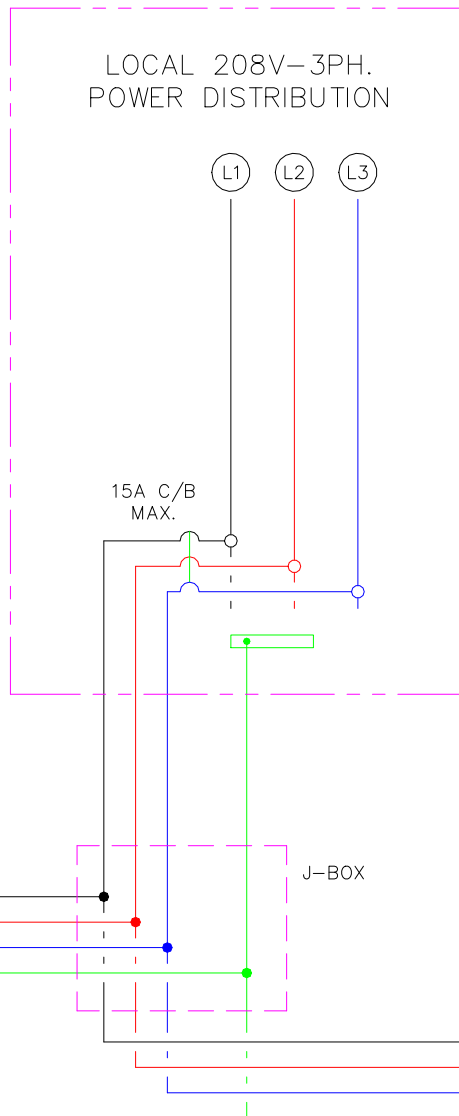
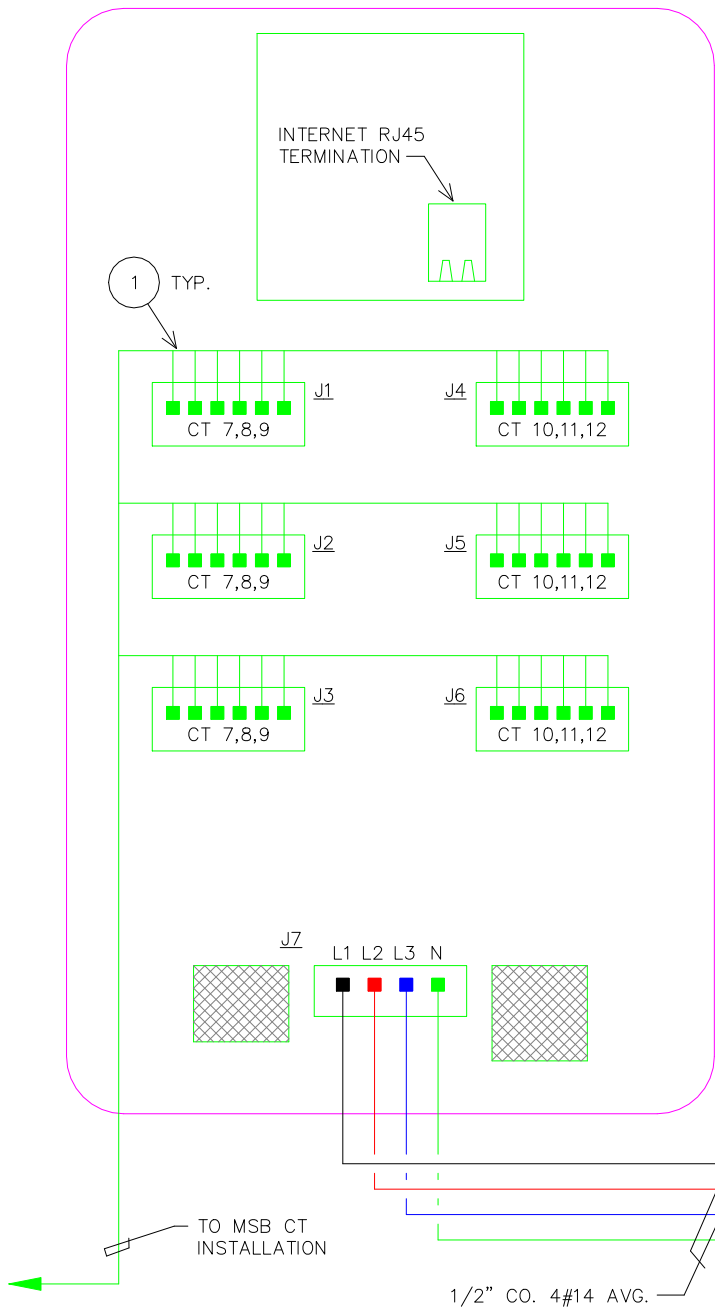
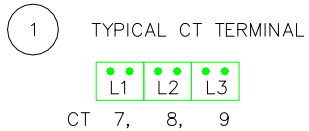

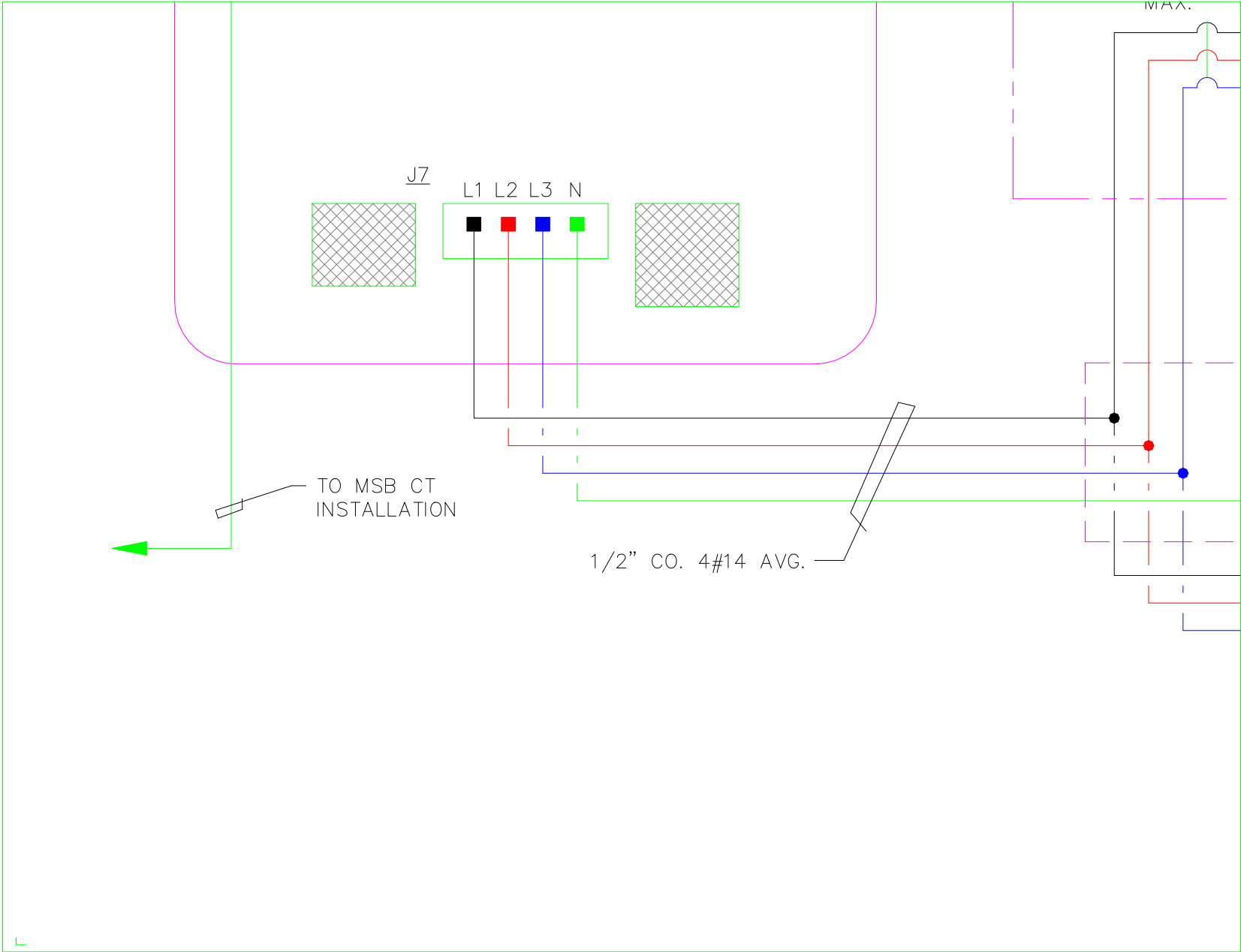

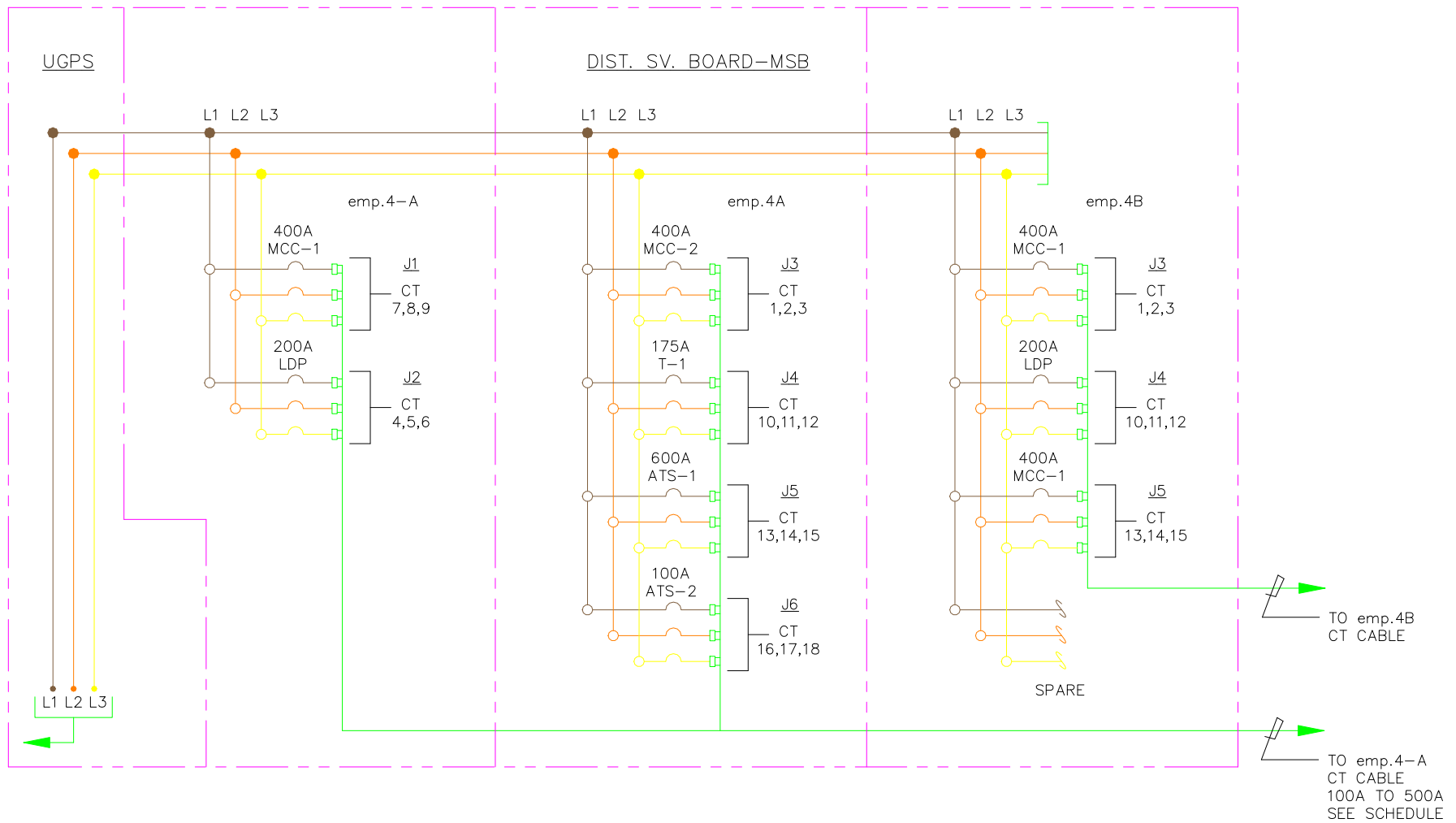



MSB_MONITORING
480v/3PH/4w

	MCC-1/400A	MCC-2/400A	ATS-3/400A
	LDP/200A	112.5 kVA xfmr 200A CB 175 A FUSE	T2-1/XFMR 400A CB/225A FUSE
INCOMING LINE SECTION		ATS-1/600A	T3-1/XFMR 400A CB/225A FUSE
		ATS-2/100A	SPACE

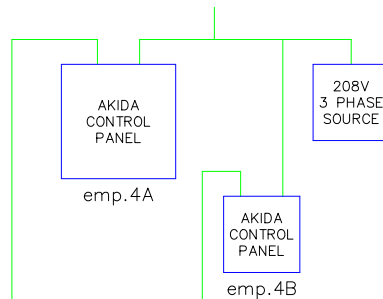
208 VOLT 3 PHASE-5#14 AWG



100A-500A "CT" AND
LOW VOLTAGE CABLE



5235 S. 39th Street
PHOENIX, AZ 85040



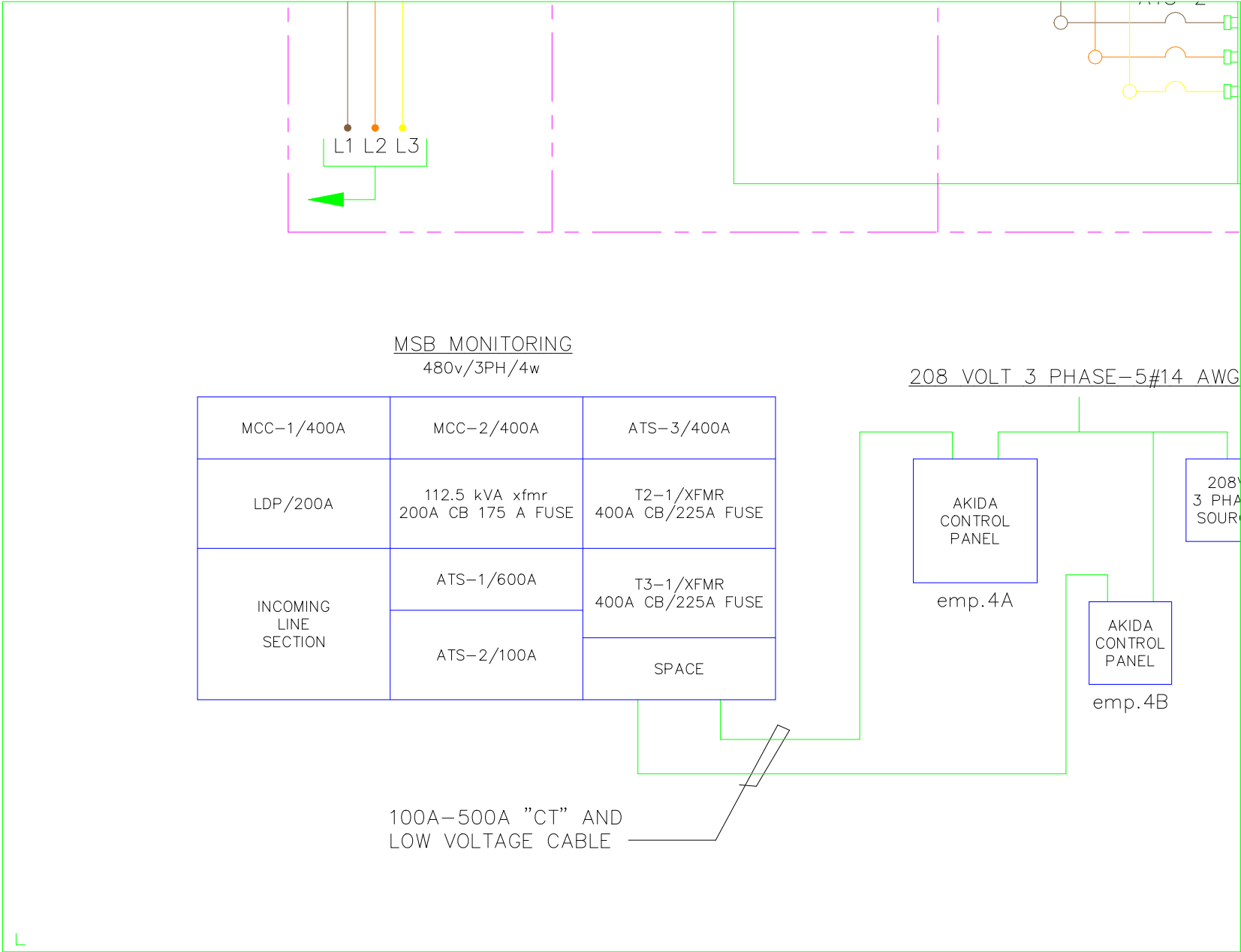

L